

SKRZYNKI ALUMINIOWE I AKCESORIA
ALUMINIUMKÄSTEN UND ZUBEHÖR
ALUMINIUM SHUTTER BOXES AND ACCESSORIES
HLINÍKOVÉ BOXY A PŘÍSLUŠENSTVÍ

KODY KOLORÓW

DIE FARBCODES

COLOR CODES

KÓDY BAREV

x	Kolor Farbe Colour Barva	RAL*
00	nielakierowany unlackiert mill finish nelakovaná	
01	srebrny silber silver stříbrná	9006
02	biały weiß white bílá	
03	szary grau grey šedá	7038
05	beżowy Beige beige béžová	
08	ciemnobrązowy dunkelbraun dark brown tmavě hnědá	8019
09	brązowy braun brown hnědá	8014
15	biel kremowa cremeweiß cream white krémová bílá	9001
22	ultra biały ultraweiß ultra white ultra bílá	9016
23	szary antracyt anthrazitgrau anthracite grey antracitová šedá	7016
26	mahoń mahagoni mahogany mahagon	
28	orzech nuss nut ořech	
30	złoty dąb goldeiche golden oak zlatý dub	
32	karmel karamel caramel karamel	
40	biały, perłowy mat weiß, perlenmatt white, pearl mat bílá, perlový mat	
41	jasny szary, perłowy mat hellgrau, perlenmatt light grey, pearl mat světle šedá, perlový mat	
42	szary, perłowy mat grau, perlenmatt grey, pearl mat šedá, perlový mat	
43	szary antracyt, perłowy mat anthrazitgrau, perlenmatt anthracite grey, pearl mat antracitová šedá, perlový mat	
44	ciemny szary, perłowy mat dunkelgrau, perlenmatt dark grey, pearl mat tmavě šedá, perlový mat	
52	winchester Winchester winchester winchester	
53	dąb ciemny dunkle Eiche dark oak tmavý dub	
99	lakier podkładowy Unterschicht-Lack primer podkladový lak	

* - kody kolorów RAL oznaczają kolory najbardziej zbliżone do kolorów rzeczywistych |
 die Code von RAL Farben bedueten die Farben, die am besten die wirklichen Farben darstellen |
 RAL colour codes mean the colours, which are most similar to the real colours |
 Kódy barev RAL označují barvy, které se nejvíce přibližují barvám skutečným

KODY ELEMENTÓW

CODES DER ELEMENTEN

CODES OF ELEMENTS

KÓDY PRVKŮ

Skrzynki roletowe i akcesoria | Rollkasten und Zubehör | Roller shutter boxes and accessories | Roletové boxy a příslušenství

	00	01	02	03	05	08	09	15	22	23	26	28	30	32	40	41	42	43	44	52	53
SK / G		x	x	x	x	x	x	x	x	x	x	x	x								
SK 45 / D		x	x	x	x	x	x	x	x	x	x	x	x								
SKE 45 / G	x	x	x	x	x	x	x			x											
SKE 45 / D	x	x	x	x	x	x	x			x											
SKE 45 / T	x	x	x	x	x	x	x			x											
SKP / D		x	x	x		x	x														
SKO-P / G		x	x	x		x	x		x	x											
SKO-P / D		x	x	x		x	x		x	x											
SKO / G	x	x	x	x		x	x		x	x					S	S	S	S	S		
SKO / D	x	x	x	x		x	x		x	x					S	S	S	S	S		
SKO / T	x	x	x	x		x	x		x	x					S	S	S	S	S		
SP 90 SK-E	x																				
SP 90 PR-E	x	x	x	x		x	x		x	x		R	R		S	S	S	S	S	R	R
SP 90 WPR-E	x	x	x	x		x	x		x	x		R	R		S	S	S	S	S	R	R
SP 90 PZ	x	x	x	x		x	x		x			R	R		S	S	S	S	S		
SP 90 PR	x	x	x	x		x	x		x			R	R		S	S	S	S	S		
SPS 90	x	x	x	x		x	x		x			R	R		S	S	S	S	S		
KT 30	x	x	x	x	x	x	x		x	x											
SPZ 90			x			x	x		x					x							
SPD 90			x	x		x	x		x					x							
BS 45	x	x	x	x	x	x	x	x	x	x	R	x	x	x							
BS_45	x	x	x	x	x	x	x	x	x	x	R	x	x	x							
BSW 45	x																				
BSW_45	x																				
BSWZ 45	x																				
BSWZ_45	x																				
BSWN 45	x																				
BSWN_45	x																				
BSP	x	x	x	x		x	x														
BSPW	x																				
BSPWZ	x																				
BSPWN	x																				
BSO	x	x	x	x		x	x		x	x					S	S	S	S	S		
BOW	x																				
BOWZ	x																				
BOWN	x																				
BS 90	x																				
BSW 90	x																				
BSWZ 90	x																				

R - Oklejane folią dekoracyjną | mit Dekorfolie furniert | Decorative foil | Polep dekorativní folií

S - Kolor specjalny na zamówienie | spezielle Farbe – auf Kundenwunsch | Special colour on request | Speciální barva na objednávku

Skrzynki bramowe i akcesoria | Torcasten und Zubehör | Shutter boxes for gates and accessories | Boxy vrat a příslušenství

	00	01	02	03	08	09	23	99
SK / G		×	×	×	×	×	×	
SK 45 / D		×	×	×	×	×	×	
SK / G / 350		×	×	×	×	×	×	
SK / T / 350		×	×	×	×	×	×	
SKO-P / G			×					×
SKO-P / D			×					×
BS 45	×	×	×	×	×	×	×	
BS 45 / K / 350	×	×	×	×	×	×	×	
BSO	×		×					

NOWE PRODUKTY

NEUE PRODUKTE

NEW PRODUCTS

NOVÉ VÝROBKY

SKE 45 / G	Skrzynka roletowa ekstrudowana 45° - góra Extrudierter Rollladenkasten 45° - Oberteil Extruded shutter box 45° - top Extrudovaný roletový box 45° - horní strana	SKE45/G/137/x SKE45/G/165/x SKE45/G/180/x SKE45/G/205/x
SKE 45 / D	Skrzynka roletowa ekstrudowana 45° - dół Extrudierter Rollladenkasten 45° - Unterteil Extruded shutter box 45° - base Extrudovaný roletový box 45° - spodní strana	SKE45/D/137/x SKE45/D/165/x SKE45/D/180/x SKE45/D/205/x SKE45/D/MKT/165/x SKE45/D/MKT/180/x
SKE 45 / T	Skrzynka roletowa ekstrudowana 45° - tył Extrudierter Rollladenkasten 45° - Rückblende Extruded shutter box 45° - back part Extrudovaný roletový box 45° - zadní strana	SKE45/T/137/x SKE45/T/165/x SKE45/T/180/x SKE45/T/205/x
SKO-P / G	Skrzynka roletowa systemu Owal - góra Rollladenkasten des OWAL-Systems – Oberteil Shutter box Owal - top Roletový box systému OWAL - horní strana	SKO-P/G/137/22 SKO-P/G/165/22 SKO-P/G/180/22
SKO-P / D	Skrzynka roletowa systemu Owal - dół Rollladenkasten des OWAL-Systems - Unterteil Shutter box Owal system - base Roletový box systému OWAL - spodní strana	SKO-P/D/137/22 SKO-P/D/165/22 SKO-P/D/180/22
SP 90 PR-E	Pokrywa rewizyjna skrzynki podtynkowej SP-E Revisionsklappe für Unterputzkasten SP-E Flap for under plaster shutter box SP-E Revizní kryt boxu pod omítkou SP-E	SP90PR-E/137/22 SP90PR-E/150/22 SP90PR-E/165/22 SP90PR-E/180/22 SP90PR-E/205/22 SP90PR-E/MKT/205/22
SP 90 WPR-E	Wspornik pokrywy rewizyjnej skrzynki podtynkowej SP-E Kragarm für Revisionsklappe des Unterputzkastens SP-E Bracket of flap for under plaster shutter box SP-E Vzpěra revizního krytu boxu pod omítkou SP-E	SP90WPR-E/15/22 SP90WPR-E/30/22
KT 30	Kątownik aluminiowy Aluminium-Winkel Aluminium angle Hliníkový úhelník	KT30/22
TR/25x13	Taśma rozprężna Ausdehnungsband Expansion tape Expanzní páska	TR/25x13
BS_45	Pokrywa boczna skrzynki 45° - stopka typ I Blendenkappen 45° - Bolzen Typ I End cap 45° - pin type I Boční kryt boxu 45° - patka typu I	BS_45/137/x BS_45/165/x BS_45/180/x BS_45/205/x
BSW_45	Bok skrzynki 45° wewnętrzny - stopka typ I Innenblendenkappen 45° - Bolzen Typ I Internal end cap 45° - pin type I Bok boxu 45° wnitřní - patka typu I	BSW_45/137/x BSW_45/165/x BSW_45/180/x BSW_45/205/x
BSWZ_45	Boki skrzynki 45° wewnętrzne, zespolone - stopka typ I Zusammengesetzte Innenblendenkappen 45° - Bolzen Typ I Compound internal end caps 45° - pin type I Boky boxu 45° wnitřně spojené - patka typu I	BSWZ_45/137/x BSWZ_45/165/x BSWZ_45/180/x BSWZ_45/205/x
BSWN_45	Bok skrzynki 45° wewnętrzny, wspólny napęd - stopka typ I Innenblendenkappen 45°, gemeinsamer Antrieb - Bolzen Typ I Internal end cap 45°, common drive - pin type I Bok boxu 45° wnitřní, společný pohon - patka typu I	BSWN_45/165/x BSWN_45/180/x BSWN_45/205/x
BSO	Pokrywa boczna skrzynki owalnej - stopka typ I Rund-Blendenkappen - Bolzen Typ I Round end cap 45° - pin type I Boční kryt owalného boxu - patka typu I	BSO/137/22 BSO/165/22 BSO/180/22 BSO/205/22

SK / G

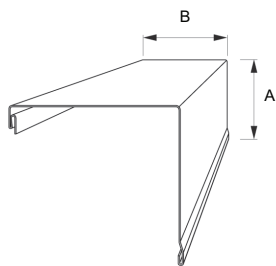

oklejane folią dekoracyjną
mit Dekorfolie beklebt
covered with a decorative foil
polepeno dekorativní folií

Skrzynka roletowa - góra
Rollladenkasten - Oberteil
Shutter box - top
Roletový box - horní strana

Pakowanie: szt. x m | Packung: St. x m | Packing: pcs. x m | Balení: ks x m

	A	B	
SK/G/125/x	128	125	5x6
SK/G/137/x	139	137	5x6
SK/G/150/x	153	150	5x6
SK/G/165/x	167	165	5x6
SK/G/180/x	183	180	5x6
SK/G/205/x	207	205	5x6

x Kolor | Farbe | Colour | Barva

01	srebrny silber silver stříbrná
02	biały weiß white bílá
03	szary grau grey šedá
05	beżowy beige beige béžová
08	ciemnobrązowy dunkelbraun dark brown tmavě hnědá
09	brązowy braun brown hnědá
15	biel kremowa cremeweiß cream white krémová bílá
22	ultra biały ultraweiß ultra white ultra bílá
23	szary antracyt anthrazitgrau anthracite grey antracitová šedá
26	mahoń mahagoni mahogany mahagon
28	orzech nuss nut ořech
30	złoty dąb goldeiche golden oak zlatý dub
30R	złoty dąb goldeiche golden oak zlatý dub

R - Oklejane folią dekoracyjną | mit Dekorfolie furniert | Decorative foil | Polep dekorativní folií

	01	02	03	05	08	09	15	22	23	26	28	30	30R
SK/G/125/x		x	x		x	x		x	x				
SK/G/137/x	x	x	x	x	x	x	x	x	x	x	x	x	x
SK/G/150/x	x	x	x	x	x	x	x	x	x				x
SK/G/165/x	x	x	x	x	x	x	x	x	x	x	x	x	x
SK/G/180/x	x	x	x	x	x	x	x	x	x	x	x	x	x
SK/G/205/x	x	x	x	x	x	x	x		x		x	x	x

Systemy SK / SAR / SKP / SP

SK 45 / D

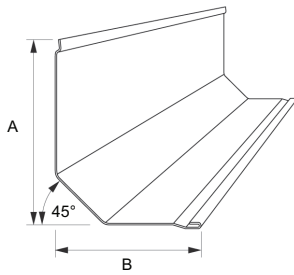

oklejane folią dekoracyjną
mit Dekorfolie beklebt
covered with a decorative foil
polepeno dekorativní folií

Skrzynka roletowa 45° - dół
Rollladenkasten 45° - Unterteil
Shutter box 45° - base
Roletový box 45° - spodní strana

Pakowanie: szt. x m | Packung: St. x m | Packing: pcs. x m | Balení: ks x m

	A	B	
SK45/D/125/x	115	90	5x6
SK45/D/137/x	127	104	5x6
SK45/D/150/x	140	114	5x6
SK45/D/165/x	155	130	5x6
SK45/D/180/x	170	144	5x6
SK45/D/205/x	195	170	5x6
SK45/D/MKT/150/x	140	104	1x6
SK45/D/MKT/165/x	155	119	1x6
SK45/D/MKT/180/x	170	133	1x6
SK45/D/MKT/205/x	195	158	1x6

x	Kolor Farbe Colour Barva
01	srebrny silber silver stříbrná
02	biały weiß white bílá
03	szary grau grey šedá
05	beżowy beige beige béžová
08	ciemnobrązowy dunkelbraun dark brown tmavě hnědá
09	brązowy braun brown hnědá
15	biel kremowa cremeweiß cream white krémová bílá
22	ultra biały ultraweiß ultra white ultra bílá
23	szary antracyt anthrazitgrau anthracite grey antracitová šedá
26	mahoń mahagoni mahogany mahagon
28	orzech nuss nut ořech
30	złoty dąb goldeiche golden oak zlatý dub
30R	złoty dąb goldeiche golden oak zlatý dub

R - Oklejane folią dekoracyjną | mit Dekorfolie furniert | Decorative foil | Polep dekorativní folií

	01	02	03	05	08	09	15	22	23	26	28	30	30R
SK45/D/125/x		x	x		x	x		x	x				
SK45/D/137/x	x	x	x	x	x	x	x	x	x	x	x	x	x
SK45/D/150/x	x	x	x	x	x	x	x	x					x
SK45/D/165/x	x	x	x	x	x	x	x	x	x	x	x	x	x
SK45/D/180/x	x	x	x	x	x	x	x	x	x	x	x	x	x
SK45/D/205/x	x	x	x	x	x	x	x		x		x	x	x
SK45/D/MKT/150/x	x	x	x	x	x	x	x	x					
SK45/D/MKT/165/x	x	x	x	x	x	x	x	x	x	x	x	x	x
SK45/D/MKT/180/x	x	x	x	x	x	x	x	x	x	x	x	x	x
SK45/D/MKT/205/x	x	x	x	x	x	x	x		x		x	x	x

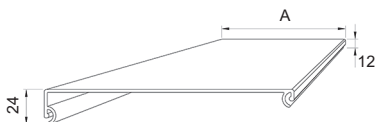
SKE 45 / G**NEW****Skrzynka roletowa ekstrudowana 45° - góra****Extrudierter Rollladenkasten 45° - Oberteil****Extruded shutter box 45° - top****Extrudovaný roletový box 45° - horní strana**

Pakowanie: szt. x m | Packung: St. x m | Packing: pcs. x m | Balení: ks x m

	A	
SKE45/G/137/x	138	5x6
SKE45/G/165/x	167	5x6
SKE45/G/180/x	182	5x6
SKE45/G/205/x	205	5x6

x	Kolor Farbe Colour Barva
00	nielakierowany unlackiert mill finish nelakovaná
01	srebrny silber silver stříbrná
02	biały weiß white bílá
03	szary grau grey šedá
05	beżowy beige beige béžová
08	ciemnobrązowy dunkelbraun dark brown tmavě hnědá
09	brązowy braun brown hnědá
23	szary antracyt anthrazitgrau anthracite grey antracitová šedá

Systemy SKE / SAR

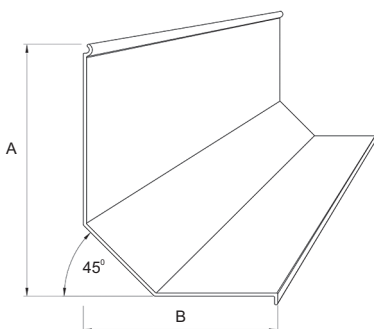
SKE 45 / D**NEW****Skrzynka roletowa ekstrudowana 45° - dół****Extrudierter Rollladenkasten 45° - Unterteil****Extruded shutter box 45° - base****Extrudovaný roletový box 45° - spodní strana**

Pakowanie: szt. x m | Packung: St. x m | Packing: pcs. x m | Balení: ks x m

	A	B	
SKE45/D/137/x	119	105	5x6
SKE45/D/165/x	148	130	5x6
SKE45/D/180/x	163	145	5x6
SKE45/D/205/x	188	164	5x6
SKE45/D/MKT/165/x	148	123	5x6
SKE45/D/MKT/180/x	163	138	5x6

x	Kolor Farbe Colour Barva
00	nielakierowany unlackiert mill finish nelakovaná
01	srebrny silber silver stříbrná
02	biały weiß white bílá
03	szary grau grey šedá
05	beżowy beige beige béžová
08	ciemnobrązowy dunkelbraun dark brown tmavě hnědá
09	brązowy braun brown hnědá
23	szary antracyt anthrazitgrau anthracite grey antracitová šedá

Systemy SKE / SAR

SKE 45 / T

NEW

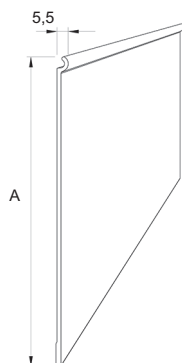

Skrzynka roletowa ekstrudowana 45° - tył
Extrudierter Rollladenkasten 45° - Hinterteil
Extruded shutter box 45° - back part
Extrudovaný roletový box 45° - zadní strana

Pakowanie: szt. x m | Packung: St. x m | Packing: pcs. x m | Balení: ks x m

	A	
SKE45/T/137/x	130	5x6
SKE45/T/165/x	160	5x6
SKE45/T/180/x	175	5x6
SKE45/T/205/x	200	5x6

x	Kolor Farbe Colour Barva
00	nie lakierowany unlackiert mill finish nelakovaná
01	srebrny silber silver stříbrná
02	biały weiß white bílá
03	szary grau grey šedá
05	beżowy beige beige béžová
08	ciemnobrązowy dunkelbraun dark brown tmavě hnědá
09	brązowy braun brown hnědá
23	szary antracyt anthrazitgrau anthracite grey antracitová šedá

Systemy SKE / SAR

SKP / D

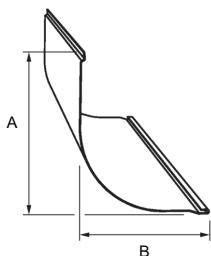

Skrzynka roletowa - dół
Rollladenkasten - Unterteil
Shutter box - base
Roletový box - spodní strana

Pakowanie: szt. x m | Packung: St. x m | Packing: pcs. x m | Balení: ks x m

	A	B	
SKP/D/137/x	129	105	5x6
SKP/D/150/x	142	115	5x6
SKP/D/165/x	157	128	5x6
SKP/D/180/x	172	143	5x6
SKP/D/205/x	197	160	5x6
SKP/D/MKT/150/x	142	101	5x6
SKP/D/MKT/165/x	157	121	5x6
SKP/D/MKT/180/x	172	136	5x6

x	Kolor Farbe Colour Barva
01	srebrny silber silver stříbrná
02	biały weiß white bílá
03	szary grau grey šedá
08	ciemnobrązowy dunkelbraun dark brown tmavě hnědá
09	brązowy braun brown hnědá

Systemy SKP / SAR

SKO-P / G

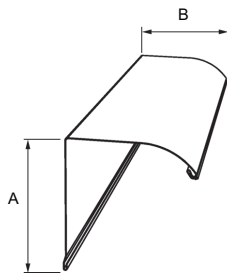

Skrzynka roletowa systemu Owal - góra
Rollladenkasten des OWAL-Systems – Oberteil
Shutter box Owal - top
Roletový box systému OWAL - horní strana

Pakowanie: szt. x m | Packung: St. x m | Packing: pcs. x m | Balení: ks x m

	A	B	
SKO-P/G/137/x	141	131	5x6
SKO-P/G/150/x	154	143	5x6
SKO-P/G/165/x	168	157	5x6
SKO-P/G/180/x	184	171	5x6
SKO-P/G/205/x	206	195	5x6

x	Kolor Farbe Colour Barva
01	srebrny silber silver stříbrná
02	biały weiß white bílá
03	szary grau grey šedá
08	ciemnobrązowy dunkelbraun dark brown tmavě hnědá
09	brązowy braun brown hnědá
NEW 22	ultra biały ultraweiß ultra white ultra bílá
23	szary antracyt anthrazitgrau anthracite grey antracitová šedá

	01	02	03	08	09	22	23
SKO-P/G/137/x	x	x	x	x	x	+	x
SKO-P/G/150/x	x	x	x	x	x		
SKO-P/G/165/x	x	x	x	x	x	+	x
SKO-P/G/180/x	x	x	x	x	x	+	x
SKO-P/G/205/x	x	x	x	x	x		

Systemy SKO-P / SAR

SKO-P / D

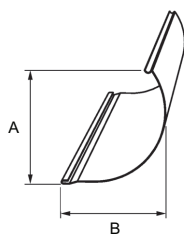

Skrzynka roletowa systemu Owal - dół
Rollladenkasten des OWAL-Systems - Unterteil
Shutter box Owal system - base
Roletový box systému OWAL - spodní strana

Pakowanie: szt. x m | Packung: St. x m | Packing: pcs. x m | Balení: ks x m

	A	B	
SKO-P/D/137/x	113	111	5x6
SKO-P/D/150/x	122	125	5x6
SKO-P/D/165/x	133	134	5x6
SKO-P/D/180/x	145	150	5x6
SKO-P/D/205/x	163	167	5x6
SKO-P/D/MKT/150/x	122	111	5x6
SKO-P/D/MKT/165/x	134	123	5x6
SKO-P/D/MKT/180/x	145	143	5x6

x	Kolor Farbe Colour Barva
01	srebrny silber silver stříbrná
02	biały weiß white bílá
03	szary grau grey šedá
08	ciemnobrązowy dunkelbraun dark brown tmavě hnědá
09	brązowy braun brown hnědá
NEW 22	ultra biały ultraweiß ultra white ultra bílá
23	szary antracyt anthrazitgrau anthracite grey antracitová šedá

	01	02	03	08	09	22	23
SKO-P/D/137/x	x	x	x	x	x	+	x
SKO-P/D/150/x	x	x	x	x	x		
SKO-P/D/165/x	x	x	x	x	x	+	x
SKO-P/D/180/x	x	x	x	x	x	+	x
SKO-P/D/205/x	x	x	x	x	x		
SKO-P/D/MKT/150/x	x	x	x	x	x		
SKO-P/D/MKT/165/x	x	x	x	x	x		
SKO-P/D/MKT/180/x	x	x	x	x	x		

Systemy SKO-P / SAR

SKO / G

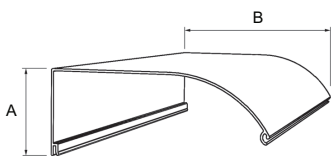

Skrzynka roletowa ekstrudowana systemu Owal - góra
Extrudierter Rollladenkasten des OWAL-Systems – Oberteil
Extruded shutter box Owal - top
Extrudovaný roletový box systému OWAL - horní strana

Pakowanie: szt. x m | Packung: St. x m | Packing: pcs. x m | Balení: ks x m

	A	B	
SKO/G/137/x	11	137	5x6
SKO/G/165/x	39	163	5x6
SKO/G/180/x	52	177	5x6
SKO/G/205/x	79	201	5x6

x	Kolor Farbe Colour Barva
00	nielakierowany unlackiert mill finish nelakovaná
01	srebrny silber silver stříbrná
02	biały weiß white bílá
03	szary grau grey šedá
08	ciemnobrązowy dunkelbraun dark brown tmavě hnědá
09	brązowy braun brown hnědá
22	ultra biały ultraweiß ultra white ultra bílá
23	szary antracyt anthrazitgrau anthracite grey antracitová šedá
40S	biały, perłowy mat weiß, perlmutt matt white, pearl mat bílá, perlový mat
41S	jasny szary, perłowy mat hellgrau, perlmutt matt light grey, pearl mat světle šedá, perlový mat
42S	szary, perłowy mat grau, perlmutt matt grey, pearl mat šedá, perlový mat
43S	szary antracyt, perłowy mat anthrazitgrau, perlmutt matt anthracite grey, pearl mat antracitová šedá, perlový mat
44S	ciemny szary, perłowy mat dunkelgrau, perlmutt matt dark grey, pearl mat tmavě šedá, perlový mat

S - Kolor specjalny na zamówienie | spezielle Farbe – auf Kundenwunsch |
 Special colour on request | Speciální barva na objednávku

Systemy SKO / SAR

SKO / D

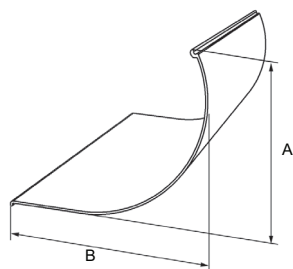

Skrzynka roletowa ekstrudowana systemu Owal - dół
Extrudierter Rollladenkasten des OWAL-Systems - Unterteil
Extruded shutter box Owal - base
Extrudovaný roletový box systému OWAL - spodní strana

Pakowanie: szt. x m | Packung: St. x m | Packing: pcs. x m | Balení: ks x m

	A	B	
SKO/D/137/x	107	102	5x6
SKO/D/165/x	128	130	5x6
SKO/D/180/x	139	145	5x6
SKO/D/205/x	159	171	5x6

x	Kolor Farbe Colour Barva
00	nielakierowany unlackiert mill finish nelakovaná
01	srebrny silber silver stříbrná
02	biały weiß white bílá
03	szary grau grey šedá
08	ciemnobrązowy dunkelbraun dark brown tmavě hnědá
09	brązowy braun brown hnědá
22	ultra biały ultraweiß ultra white ultra bílá
23	szary antracyt anthrazitgrau anthracite grey antracitová šedá
40S	biały, perłowy mat weiß, perlmutt matt white, pearl mat bílá, perlový mat
41S	jasny szary, perłowy mat hellgrau, perlmutt matt light grey, pearl mat světle šedá, perlový mat
42S	szary, perłowy mat grau, perlmutt matt grey, pearl mat šedá, perlový mat
43S	szary antracyt, perłowy mat anthrazitgrau, perlmutt matt anthracite grey, pearl mat antracitová šedá, perlový mat
44S	ciemny szary, perłowy mat dunkelgrau, perlmutt matt dark grey, pearl mat tmavě šedá, perlový mat

S - Kolor specjalny na zamówienie | spezielle Farbe – auf Kundenwunsch |
 Special colour on request | Speciální barva na objednávku

Systemy SKO / SAR

SKO / T

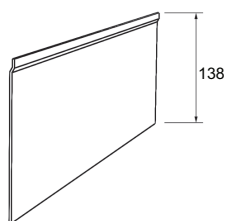

Skrzynka roletowa ekstrudowana systemu Owal - tył
Extrudierter Rollladenkasten des OWAL-Systems – Hinterteil
Extruded shutter box Owal - back part
Extrudovaný roletový box systému OWAL - zadní strana

Pakowanie: szt. x m | Packung: St. x m | Packing: pcs. x m | Balení: ks x m

- SKO/T/x**
- do zastosowania w skrzynkach typu SKO od 137 do 205
 - für die Verwendung im Kasten vom Typ SKO von 138 bis 205
 - used in shutter boxes SKO, size from 137 to 205
 - pro použití v boxech typu SKO od 137 do 205

x	Kolor Farbe Colour Barva	
00	nielakierowany unlackiert mill finish nelakovaná	5x6
01	srebrny silber silver stříbrná	5x6
02	biały weiß white bílá	5x6
03	szary grau grey šedá	5x6
08	ciemnobrązowy dunkelbraun dark brown tmavě hnědá	5x6
09	brązowy braun brown hnědá	5x6
22	ultra biały ultraweiß ultra white ultra bílá	5x6
23	szary antracyt anthrazitgrau anthracite grey antracitová šedá	5x6
40S	biały, perłowy mat weiß, perlmutt matt white, pearl mat bílá, perlový mat	5x6
41S	jasny szary, perłowy mat hellgrau, perlmutt matt light grey, pearl mat světle šedá, perlový mat	5x6
42S	szary, perłowy mat grau, perlmutt matt grey, pearl mat šedá, perlový mat	5x6
43S	szary antracyt, perłowy mat anthrazitgrau, perlmutt matt anthracite grey, pearl mat antracitová šedá, perlový mat	5x6
44S	ciemny szary, perłowy mat dunkelgrau, perlmutt matt dark grey, pearl mat tmavě šedá, perlový mat	5x6

S - Kolor specjalny na zamówienie | spezielle Farbe – auf Kundenwunsch | Special colour on request | Speciální barva na objednávku

Systemy SKO / SAR

SP 90 SK-E

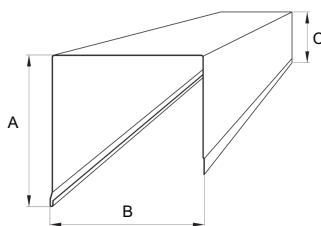

Skrzynka roletowa SP-E
Rollladenkasten SP-E
Shutter box SP-E
Roletový box SP-E

Pakowanie: szt. x m | Packung: St. x m | Packing: pcs. x m | Balení: ks x m

	A	B	C	
SP90SK-E/137/x	137	137	98	5x6
SP90SK-E/150/x	150	150	112	5x6
SP90SK-E/165/x	165	164	126	5x6
SP90SK-E/180/x	180	180	142	5x6
SP90SK-E/205/x	205	205	167	5x6

x	Kolor Farbe Colour Barva
00	nielakierowany unlackiert mill finish nelakovaná

Systemy SP-E / SAR

SP 90 PR-E

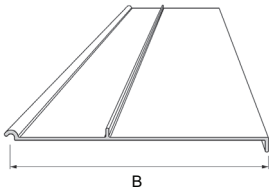

oklejane folią dekoracyjną
mit Dekorfolie beklebt
covered with a decorative foil
polepeno dekorativní folií

Pokrywa rewizyjna skrzynki podtynkowej SP-E
Revisionsklappe für Unterputzkasten SP-E
Flap for under plaster shutter box SP-E
Revizní kryt boxu pod omítkou SP-E

Pakowanie: szt. x m | Packung: St. x m | Packing: pcs. x m | Balení: ks x m

	B	
SP90PR-E/137/x	111	5x6
SP90PR-E/150/x	126	5x6
SP90PR-E/165/x	139	5x6
SP90PR-E/180/x	150	5x6
SP90PR-E/205/x	171	5x6
SP90PR-E/MKT/205/x	165	5x6

x	Kolor Farbe Colour Barva
00	nie lakierowany unlackiert mill finish nelakovaná
01	srebrny silber silver stříbrná
02	biały weiß white bílá
03	szary grau grey šedá
08	ciemnobrązowy dunkelbraun dark brown tmavě hnědá
09	brązowy braun brown hnědá
NEW 22	ultra biały ultraweiß ultra white ultra bílá
23	szary antracyt anthrazitgrau anthracite grey antracitová šedá
28R	orzech nuss nut ořech
30R	złoty dąb goldeiche golden oak zlatý dub
40S	biały, perłowy mat weiß, perlmutt matt white, pearl mat bílá, perlový mat
41S	jasny szary, perłowy mat hellgrau, perlmutt matt light grey, pearl mat světle šedá, perlový mat
42S	szary, perłowy mat grau, perlmutt matt grey, pearl mat šedá, perlový mat
43S	szary antracyt, perłowy mat anthrazitgrau, perlmutt matt anthracite grey, pearl mat antracitová šedá, perlový mat
44S	ciemny szary, perłowy mat dunkelgrau, perlmutt matt dark grey, pearl mat tmavě šedá, perlový mat
52R	winchester Winchester winchester winchester
53R	dąb ciemny dunkel Eiche dark oak tmavý dub

R - Oklejane folią dekoracyjną | mit Dekorfolie furniert | Decorative foil | Polep dekorativní folií

S - Kolor specjalny na zamówienie | spezielle Farbe – auf Kundenwunsch | Special colour on request | Speciální barva na objednávku

Systemy SP-E / SAR

SP 90 WPR-E

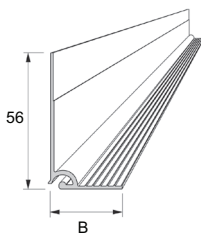

oklejane folią dekoracyjną
mit Dekorfolie beklebt
covered with a decorative foil
polepeno dekorativní folií

Wspornik pokrywy rewizyjnej skrzynki podtynkowej SP-E
Kragarm für Revisionsklappe des Unterputzkastens SP-E
Bracket of flap for under plaster shutter box SP-E
Vzpěra revizního krytu boxu pod omítkou SP-E

Pakowanie: szt. x m | Packung: St. x m | Packing: pcs. x m | Balení: ks x m

	B	
SP90WPR-E/15/x	15	5x6
SP90WPR-E/30/x	30	5x6
SP90WPR-E/45/x	45	5x6
SP90WPR-E/105/x	105	5x6

x	Kolor Farbe Colour Barva
00	nielakerowany unlackiert mill finish nelakovaná
01	srebrny silber silver stříbrná
02	biały weiß white bílá
03	szary grau grey šedá
08	ciemnobrązowy dunkelbraun dark brown tmavě hnědá
09	brązowy braun brown hnědá
NEW 22	ultra biały ultraweiß ultra white ultra bílá
23	szary antracyt anthrazitgrau anthracite grey antracitová šedá
28R	orzech nuss nut ořech
30R	złoty dąb goldeiche golden oak zlatý dub
40S	biały, perłowy mat weiß, perlmutt matt white, pearl mat bílá, perlový mat
41S	jasny szary, perłowy mat hellgrau, perlmutt matt light grey, pearl mat světle šedá, perlový mat
42S	szary, perłowy mat grau, perlmutt matt grey, pearl mat šedá, perlový mat
43S	szary antracyt, perłowy mat anthrazitgrau, perlmutt matt anthracite grey, pearl mat antracitová šedá, perlový mat
44S	ciemny szary, perłowy mat dunkelgrau, perlmutt matt dark grey, pearl mat tmavě šedá, perlový mat
52R	winchester Winchester winchester winchester
53R	dąb ciemny dunkel Eiche dark oak tmavý dub

R - Oklejane folią dekoracyjną | mit Dekorfolie furniert | Decorative foil | Polep dekorativní folií
S - Kolor specjalny na zamówienie | spezielle Farbe – auf Kundenwunsch | Special colour on request | Speciální barva na objednávku

	00	01	02	03	08	09	22	23	28R	30R	40S	41S	42S	43S	44S	52R	53R
SP90WPR-E/15/x	x	x	x	x	x	x	+	x	x	x	x	x	x	x	x	x	x
SP90WPR-E/30/x	x	x	x	x	x	x	+	x	x	x	x	x	x	x	x	x	x
SP90WPR-E/45/x	x		x	x	x	x		x			x	x	x	x	x		
SP90WPR-E/105/x	x		x	x	x	x		x			x	x	x	x	x		

Systemy SP-E / SAR

SP 90 SPD-E

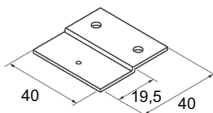

Listwa dystansowa do skrzynki podtynkowej SP-E
Distanzleiste für Unterputzkasten SP-E
Distance slat for under plaster shutter box SP-E
Distanční lišta k boxu pod omítkou SP-E

Pakowanie: 100 szt. | Packung: 100 St. | Packing: 100 pcs | Balení: 100 ks

SP90SPD-E

Systemy SP-E / SAR

SP 90 PZ

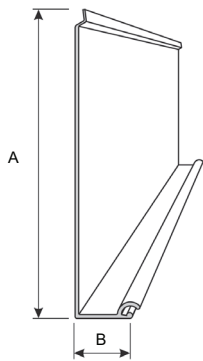

oklejane folią dekoracyjną
mit Dekorfolie beklebt
covered with a decorative foil
polepeno dekorativní folií

Pokrywa zewnętrzna skrzynki podtynkowej SP

Außenelement des Unterputzkastens SP

Outer cap for under plaster shutter box SP

Vnější kryt boxu pod omítkou SP

Pakowanie: szt. x m | Packung: St. x m | Packing: pcs. x m | Balení: ks x m

	A	B	
SP90PZ/137/x	127	26	5x6
SP90PZ/165/x	155	29	5x6
SP90PZ/180/x	171	37	5x6
SP90PZ/205/x	195	37	5x6

x	Kolor Farbe Colour Barva
00	nie lakierowany unlackiert mill finish nelakovaná
01	srebrny silber silver stříbrná
02	biały weiß white bílá
03	szary grau grey šedá
08	ciemnobrązowy dunkelbraun dark brown tmavě hnědá
09	brązowy braun brown hnědá
23	szary antracyt anthrazitgrau anthracite grey antracitová šedá
28R	orzech nuss nut ořech
30R	złoty dąb goldeiche golden oak zlatý dub
40S	biały, perłowy mat weiß, perlmutt matt white, pearl mat bílá, perlový mat
41S	jasny szary, perłowy mat hellgrau, perlmutt matt light grey, pearl mat světle šedá, perlový mat
42S	szary, perłowy mat grau, perlmutt matt grey, pearl mat šedá, perlový mat
43S	szary antracyt, perłowy mat anthrazitgrau, perlmutt matt anthracite grey, pearl mat antracitová šedá, perlový mat
44S	ciemny szary, perłowy mat dunkelgrau, perlmutt matt dark grey, pearl mat tmavě šedá, perlový mat

R - Oklejane folią dekoracyjną | mit Dekorfolie furniert | Decorative foil | Polep dekorativní folií

S - Kolor specjalny na zamówienie | spezielle Farbe – auf Kundenwunsch | Special colour on request | Speciální barva na objednávku

SP 90 PR

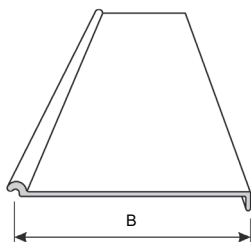

oklejane folią dekoracyjną
mit Dekorfolie beklebt
covered with a decorative foil
polepeno dekorativní folií

Pokrywa rewizyjna skrzynki podtynkowej SP
Revisionsklappe des Unterputzkastens SP
Flap for under plaster shutter box SP
Revizní kryt boxu pod omítkou SP

Pakowanie: szt. x m | Packung: St. x m | Packing: pcs. x m | Balení: ks x m

	B	
SP90PR/137/x	82	5x6
SP90PR/165/x	100	5x6
SP90PR/180/x	109	5x6
SP90PR/205/x	134	5x6

x	Kolor Farbe Colour Barva
00	nielakerowany unlackiert mill finish nelakovaná
01	srebrny silber silver stříbrná
02	biały weiß white bílá
03	szary grau grey šedá
08	ciemnobrązowy dunkelbraun dark brown tmavě hnědá
09	brązowy braun brown hnědá
23	szary antracyt anthrazitgrau anthracite grey antracitová šedá
28R	orzech nuss nut ořech
30R	złoty dąb goldeiche golden oak zlatý dub
40S	biały, perłowy mat weiß, perlmutt matt white, pearl mat bílá, perlový mat
41S	jasny szary, perłowy mat hellgrau, perlmutt matt light grey, pearl mat světle šedá, perlový mat
42S	szary, perłowy mat grau, perlmutt matt grey, pearl mat šedá, perlový mat
43S	szary antracyt, perłowy mat anthrazitgrau, perlmutt matt anthracite grey, pearl mat antracitová šedá, perlový mat
44S	ciemny szary, perłowy mat dunkelgrau, perlmutt matt dark grey, pearl mat tmavě šedá, perlový mat

R - Oklejane folią dekoracyjną | mit Dekorfolie furniert | Decorative foil | Polep dekorativní folií

S - Kolor specjalny na zamówienie | spezielle Farbe – auf Kundenwunsch | Special colour on request | Speciální barva na objednávku

Systemy SP / SAR

SPS 90

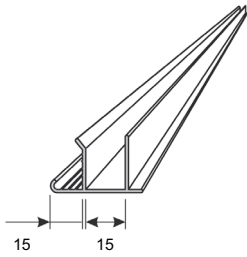

oklejane folią dekoracyjną
mit Dekorfolie beklebt
covered with a decorative foil
polepeno dekorativní folií

Szyna tynkowa
Putzschiene für Unterputzkasten SP
Bar for under plaster shutter box SP
Omítková kolejnice k boxům pod omítkou SP

Pakowanie: szt. x m | Packung: St. x m | Packing: pcs. x m | Balení: ks x m

SPS90/x

x	Kolor Farbe Colour Barva	
00	nielakierowany unlackiert mill finish nelakovaná	5x6
01	srebrny silber silver stříbrná	5x6
02	biały weiß white bílá	5x6
03	szary grau grey šedá	5x6
08	ciemnobrązowy dunkelbraun dark brown tmavě hnědá	5x6
09	brązowy braun brown hnědá	5x6
23	szary antracyt anthrazitgrau anthracite grey antracitová šedá	5x6
28R	orzech nuss nut ořech	5x6
30R	złoty dąb goldeiche golden oak zlatý dub	5x6
40S	biały, perłowy mat weiß, perlmutt matt white, pearl mat bílá, perlový mat	5x6
41S	jasny szary, perłowy mat hellgrau, perlmutt matt light grey, pearl mat světle šedá, perlový mat	5x6
42S	szary, perłowy mat grau, perlmutt matt grey, pearl mat šedá, perlový mat	5x6
43S	szary antracyt, perłowy mat anthrazitgrau, perlmutt matt anthracite grey, pearl mat antracitová šedá, perlový mat	5x6
44S	ciemny szary, perłowy mat dunkelgrau, perlmutt matt dark grey, pearl mat tmavě šedá, perlový mat	5x6

R - Oklejane folią dekoracyjną | mit Dekorfolie furniert | Decorative foil | Polep dekorativní folií

S - Kolor specjalny na zamówienie | spezielle Farbe – auf Kundenwunsch | Special colour on request | Speciální barva na objednávku

Systemy SP / SAR

KT 30

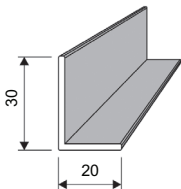

Kątownik aluminiowy
Aluminium-Winkel
Aluminium angle
Hliníkový úhelník

Pakowanie: szt. x m | Packung: St. x m | Packing: pcs. x m | Balení: ks x m

KT30/x

- do podparcia prowadnicy lub jako nośnik tynku
- zur Stütze der Führungsschiene oder als Putzträger
- to support the guide channel or as plaster foundation
- k podepření vodící lišty nebo jako nosič omítky

x	Kolor Farbe Colour Barva	
00	nielakierowany unlackiert mill finish nelakovaná	1x6
01	srebrny silber silver stříbrná	1x6
02	biały weiß white bílá	1x6
03	szary grau grey šedá	1x6
05	beżowy beige beige béžová	1x6
08	ciemnobrązowy dunkelbraun dark brown tmavě hnědá	1x6
09	brązowy braun brown hnědá	1x6
NEW 22	ultra biały ultraweiß ultra white ultra bílá	1x6
23	szary antracyt anthrazitgrau anthracite grey antracitová šedá	1x6

Systemy SK / SKE / SKO / SKO-P / SKP / SP / SP-E

SPZ 90

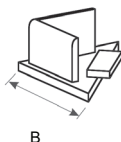

Zašlepka do skrzynki podtynkowej SP
Eckelement für Unterputzkasten SP
Blind for under plaster shutter box SP
Záslepka k boxu pod omítkou SP

Pakowanie: szt. | Packung: St. | Packing: pcs | Balení: ks

	B	
SPZ90/137/x	36	100
SPZ90/165/x	47	100
SPZ90/180/x	50	100
SPZ90/205/x	55	100

x	Kolor Farbe Colour Barva
02	biały weiß white bílá
08	ciemnobrązowy dunkelbraun dark brown tmavě hnědá
09	brązowy braun brown hnědá
23	szary antracyt anthrazitgrau anthracite grey antracitová šedá
32	karmel karamel caramel karamel

Systemy SP / SAR

SPD 90

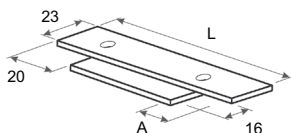

Listwa dystansowa do skrzynki podtynkowej SP
Distanzleiste für Unterputzkasten SP
Distance slat for under plaster shutter box SP
Distanční lišta k boxu pod omítkou SP

Pakowanie: szt. | Packung: St. | Packing: pcs | Balení: ks

	A	L	
SPD90/137/x	15	76	100
SPD90/165/x	20	99	100
SPD90/180/x	20	108	100
SPD90/205/x	20	133	100

x	Kolor Farbe Colour Barva
02	biały weiß white bílá
03	szary grau grey šedá
08	ciemnobrązowy dunkelbraun dark brown tmavě hnědá
09	brązowy braun brown hnědá
23	szary antracyt anthrazitgrau anthracite grey antracitová šedá
32	karmel karamel caramel karamel

Systemy SP / SAR

WZ 90 PR

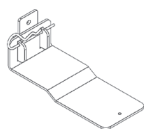

Wzmocnienie pokrywy rewizyjnej
Verstärkung der Revisionsklappe
Shutter box reinforcement
Zpevnění revizního krytu

Pakowanie: 1 szt. | Packung: 1 St. | Packing: 1 pcs | Balení: 1 ks

- WZ90PR/119**
- stosowane w skrzynkach: SP 165; SP-E 165
 - verwendet in den Kästen: SP 165; SP-E 165
 - used in shutter boxes: SP 165; SP-E 165
 - používáno v boxech: SP 165; SP-E 165
- WZ90PR/140**
- stosowane w skrzynkach: SP 180; SP 205; SP-E 180; SP-E 205
 - verwendet in den Kästen: SP 180; SP 205; SP-E 180; SP-E 205
 - used in shutter boxes: SP 180; SP 205; SP-E 180; SP-E 205
 - používáno v boxech: SP 180; SP 205; SP-E 180; SP-E 205

Systemy SP / SP-E / SAR

K/PU

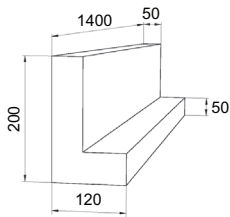

Kątownik poliuretanowy
Polyurethan-Winkel
Polyurethane angle
Polyuretanový úhelník

Pakowanie: 1 szt. | Packung: 1 St. | Packing: 1 pcs | Balení: 1 ks

K/PU

- kątownik stosowany do montażu skrzynki z nadprożem. Wymagany przy montażu PHI
- Winkel - verwendet zur Montage des Kastens mit dem Sturz. Erforderlich bei der PHI Montage
- angle used to mount the box with the lintel. Required for installation of PHI
- úhelník používaný k montáži boxu do nadpraží. Nutné při montáži PHI

Systemy SP / SP-E

TR/25x13

NEW

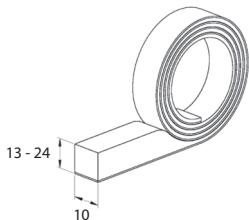

Taśma rozprężna
Ausdehnungsband
Expansion tape
Expanzní páska

Pakowanie: 1x6,6 szt. x m | Packung: 1x6,6 St. x m | Packing: 1x6,6 pcs. x m | Balení: 1x6,6 ks x m

TR/25x13

- taśma stosowana do uszczelnienia spoin. Wymagana przy montażu PHI
- Band verwendet zur versiegelung der Fugen. Erforderlich bei der PHI Montage.
- tape used to seal joints. Required for installation of PHI
- páska používaná pro utěsnění spojů. Nutné při montáži PHI

Systemy SP / SP-E

NT/XPS

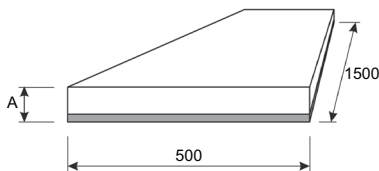

Nośnik tynku (Styrodur XPS)
Putzträger (Styrodur XPS)
Plaster foundation (Styrodur XPS)
Nosič omítky (Styrodur XPS)

Pakowanie: szt. | Packung: St. | Packing: pcs | Balení: ks

NT/XPS

- posiada powłokę samoprzylepną, stosowany z: SP 90 WPR-E, SPS 90, KT 30, NT
- mit Selbstklebendbeschichtung, verwendet mit: SP 90 WPR-E, SPS 90, KT 30, NT
- it has a self-adhesive layer, used with: SP 90 WPR-E, SPS 90, KT 30, NT
- je vybaven samolepicím povrchem, používáno s: SP 90 WPR-E, SPS 90, KT 30, NT

	A	
NT/XPS/8	8	1
NT/XPS/10	10	1
NT/XPS/16	16	1
NT/XPS/22	22	1

Systemy SP / SP-E / SKT / SAR

NT/HR

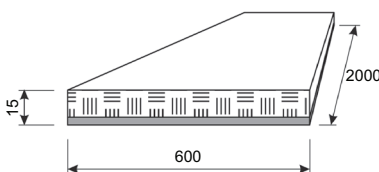

Nośnik tynku (Heraklith)
Putzträger (Heraklith)
Plaster foundation (Heraklith)
Nosič omítky (Heraklith)

Pakowanie: 1 szt. | Packung: 1 St. | Packing: 1 pcs | Balení: 1 ks

NT/HR

- stosowany z: SP 90 WPR-E, SPS 90, KT 30
- verwendet mit: SP 90 WPR-E, SPS 90, KT 30
- used with: SP 90 WPR-E, SPS 90, KT 30
- používáno s: SP 90 WPR-E, SPS 90, KT 30

Systemy SP / SP-E / SAR

WPB

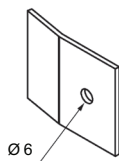

Wspornik do montażu pokryw bocznych

Montageplatte für Blendenkappen

Plate for end caps

Podpěra pro montáž bočních krytů

Pakowanie: 1 szt. | Packung: 1 St. | Packing: 1 pcs | Balení: 1 ks

WPB

- do montażu pokryw bocznych: BS_45, BS 45, BSP, BSO, BS 90
- für die Montage der Blendenkappen: BS_45, BS 45, BSP, BSO, BS 90
- for end caps installation: BS_45, BS 45, BSP, BSO, BS 90
- k montáži bočních krytů: BS_45, BS 45, BSP, BSO, BS 90

Systemy SK / SKE / SKP / SKO / SKO-P / SP / SP-E / SAR

BS 45

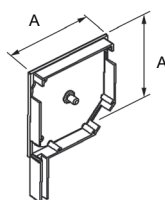

oklejane folią dekoracyjną
mit Dekorfolie beklebt
covered with a decorative foil
polepeno dekorativní folií

Pokrywa boczna skrzynki 45° - stopka typ I

Blendenkappen 45° - Bolzen Typ I

End cap 45° - pin type I

Boční kryt boxu 45° - patka typu I

Pakowanie: para | Packung: Paar | Packing: pair | Balení: pár

	A	
BS45/125/x	126	25
BS45/137/x	138	25
BS45/150/x	151	25
BS45/165/x*	166	25
BS45/180/x*	181	25
BS45/205/x*	206	15

* - Dostępne do wyczerpania zapasów | Erhältlich solange der Vorrat reicht | Available while stock lasts | Dostupné do vyčerpání zásob

x Kolor | Farbe | Colour | Barva

00	nielakerowany unlackiert mill finish nelakovaná
01	srebrny silber silver stříbrná
02	biały weiß white bílá
03	szary grau grey šedá
05	beżowy beige beige béžová
08	ciemnobrązowy dunkelbraun dark brown tmavě hnědá
09	brązowy braun brown hnědá
15	biel kremowa cremeweiß cream white krémová bílá
22	ultra biały ultraweiß ultra white ultra bílá
23	szary antracyt anthrazitgrau anthracite grey antracitová šedá
26R	mahoń mahagoni mahogany mahagon
28	orzech nuss nut ořech
28R	orzech nuss nut ořech
30	złoty dąb goldeiche golden oak zlatý dub
30R	złoty dąb goldeiche golden oak zlatý dub
32	karmel karamel caramel karamel

R - Oklejane folią dekoracyjną | mit Dekorfolie furniert | Decorative foil | Polep dekorativní folií

	00	01	02	03	05	08	09	15	22	23	26R	28	28R	30	30R	32
BS45/125/x	x		x	x		x	x		x	x						
BS45/137/x	x	x	x	x	x	x	x	x	x	x	x	x	x	x	x	x
BS45/150/x	x	x	x	x	x	x	x	x	x	x					x	x
BS45/165/x	x	x	x	x	x	x	x	x	x	x	x	x	x	x	x	x
BS45/180/x	x	x	x	x	x	x	x	x	x	x	x	x	x	x	x	x
BS45/205/x	x	x	x	x	x	x	x	x		x	x	x	x	x	x	x

Systemy SK / SP / SAR

BS_45

NEW

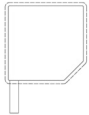
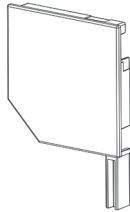
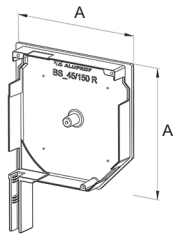

oklejane folią dekoracyjną
mit Dekorfolie beklebt
covered with a decorative foil
polepeno dekorativní folií

Pokrywa boczna skrzynki 45° - stopka typ I

Blendenkappen 45° - Bolzen Typ I

End cap 45° - pin type I

Boční kryt boxu 45° - patka typu I

Pakowanie: para | Packung: Paar | Packing: pair | Balení: pár

	A	
BS_45/137/x	140	25
BS_45/165/x	168	25
BS_45/180/x	183	25
BS_45/205/x	208	15

x	Kolor Farbe Colour Barva
00	nie lakierowany unlackiert mill finish nelakovaná
01	srebrny silber silver stříbrná
02	biały weiß white bílá
03	szary grau grey šedá
05	beżowy beige beige béžová
08	ciemnobrązowy dunkelbraun dark brown tmavě hnědá
09	brązowy braun brown hnědá
15	biel kremowa cremeweiß cream white krémová bílá
22	ultra biały ultraweiß ultra white ultra bílá
23	szary antracyt anthrazitgrau anthracite grey antracitová šedá
26R	mahoń mahagoni mahogany mahagon
28	orzech nuss nut ořech
28R	orzech nuss nut ořech
30	złoty dąb goldeiche golden oak zlatý dub
30R	złoty dąb goldeiche golden oak zlatý dub
32	karmel karamel caramel karamel

R - Oklejane folią dekoracyjną | mit Dekorfolie furniert | Decorative foil | Polep dekorativní folií

	00	01	02	03	05	08	09	15	22	23	26R	28	28R	30	30R	32
BS_45/137/x	x	x	x	x	x	x	x	x	x	x	x	x	x	x	x	x
BS_45/165/x	x	x	x	x	x	x	x	x	x	x	x	x	x	x	x	x
BS_45/180/x	x	x	x	x	x	x	x	x	x	x	x	x	x	x	x	x
BS_45/205/x	x	x	x	x	x	x	x	x		x	x	x	x	x	x	x

Systemy SK / SKE / SP / SAR

BSW 45

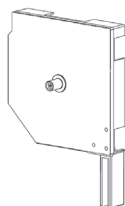
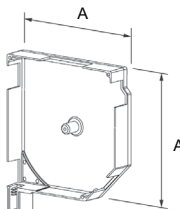

Bok skrzynki 45° wewnętrzny - stopka typ I

Innenblendenkappen 45° - Bolzen Typ I

Internal end cap 45° - pin type I

Bok boxu 45° wnitřní - patka typu I

Pakowanie: para | Packung: Paar | Packing: pair | Balení: pár

	A	
BSW45/137/x*	135	1
BSW45/150/x	148	1
BSW45/165/x*	163	1
BSW45/180/x*	178	1
BSW45/205/x*	203	1

* - Dostępne do wyczerpania zapasów | Erhältlich solange der Vorrat reicht | Available while stock lasts | Dostupné do vyčerpání zásob

x	Kolor Farbe Colour Barva
00	nie lakierowany unlackiert mill finish nelakovaná

Systemy SK / SP

BSW_45

NEW

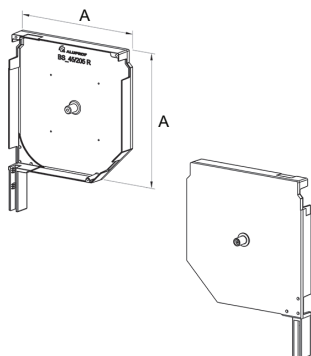

Bok skrzynki 45° wewnętrzny - stopka typ I
Innenblendenkappen 45° - Bolzen Typ I
Internal end cap 45° - pin type I
Bok boxu 45° vnitřní - patka typu I

Pakowanie: para | Packung: Paar | Packing: pair | Balení: pár

	A	
BSW_45/137/x	135	1
BSW_45/165/x	163	1
BSW_45/180/x	178	1
BSW_45/205/x	203	1

x Kolor | Farbe | Colour | Barva

00 nielakierowany | unlackiert | mill finish | nelakovaná

Systemy SK / SKE / SP

BSWZ 45

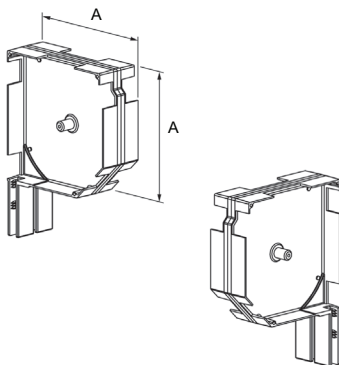

Boki skrzynki 45° wewnętrzne, zespolone - stopka typ I
Zusammengesetzte Innenblendenkappen 45° - Bolzen Typ I
Compound internal end caps 45° - pin type I
Boky boxu 45° vnitřně spojené - patka typu I

Pakowanie: para | Packung: Paar | Packing: pair | Balení: pár

	A	
BSWZ45/137/x*	135	1
BSWZ45/150/x	148	1
BSWZ45/165/x*	163	1
BSWZ45/180/x*	178	1
BSWZ45/205/x*	203	1

* - Dostępne do wyczerpania zapasów | Erhältlich solange der Vorrat reicht | Available while stock lasts | Dostupné do vyčerpání zásob

x Kolor | Farbe | Colour | Barva

00 nielakierowany | unlackiert | mill finish | nelakovaná

Systemy SK / SP

BSWZ_45

NEW

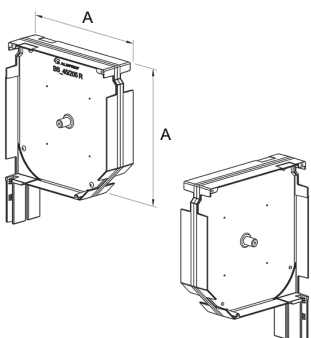

Boki skrzynki 45° wewnętrzne, zespolone - stopka typ I
Zusammengesetzte Innenblendenkappen 45° - Bolzen Typ I
Compound internal end caps 45° - pin type I
Boky boxu 45° vnitřně spojené - patka typu I

Pakowanie: para | Packung: Paar | Packing: pair | Balení: pár

	A	
BSWZ_45/137/x	135	1
BSWZ_45/165/x	163	1
BSWZ_45/180/x	178	1
BSWZ_45/205/x	203	1

x Kolor | Farbe | Colour | Barva

00 nielakierowany | unlackiert | mill finish | nelakovaná

Systemy SK / SKE / SP

BSWN 45

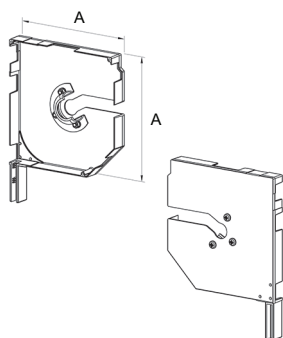

Bok skrzynki 45° wewnętrzny, wspólny napęd - stopka typ I
Innenblendenkappen 45°, gemeinsamer Antrieb - Bolzen Typ I
Internal end cap 45°, common drive - pin type I
Bok boxu 45° vnitřní, společný pohon - patka typu I

Pakowanie: para | Packung: Paar | Packing: pair | Balení: pár

	A	
BSWN45/150/x	148	1
BSWN45/165/x*	163	1
BSWN45/180/x*	178	1
BSWN45/205/x*	203	1

* - Dostępne do wyczerpania zapasów | Erhältlich solange der Vorrat reicht | Available while stock lasts | Dostupné do vyčerpání zásob

x Kolor | Farbe | Colour | Barva

00 nielakierowany | unlackiert | mill finish | nelakovaná

System SK

BSWN_45

NEW

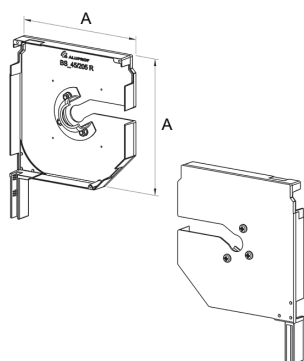

Bok skrzynki 45° wewnętrzny, wspólny napęd - stopka typ I
Innenblendenkappen 45°, gemeinsamer Antrieb - Bolzen Typ I
Internal end cap 45°, common drive - pin type I
Bok boxu 45° vnitřní, společný pohon - patka typu I

Pakowanie: para | Packung: Paar | Packing: pair | Balení: pár

	A	
BSWN_45/165/x	163	1
BSWN_45/180/x	178	1
BSWN_45/205/x	203	1

x Kolor | Farbe | Colour | Barva

00 nielakierowany | unlackiert | mill finish | nelakovaná

System SK

BSP

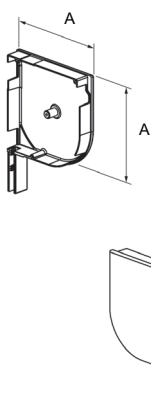

Pokrywa boczna skrzynki - stopka typ I
Blendenkappen - Bolzen Typ I
End cap - pin type I
Boční kryt boxu - patka typu I

Pakowanie: para | Packung: Paar | Packing: pair | Balení: pár

	A	
BSP/137/x	137	25
BSP/150/x	151	25
BSP/165/x	166	25
BSP/180/x	181	25
BSP/205/x	206	25

x Kolor | Farbe | Colour | Barva

00 nielakierowany | unlackiert | mill finish | nelakovaná

01 srebrny | silber | silver | stříbrná

02 biały | weiß | white | bílá

03 szary | grau | grey | šedá

08 ciemnobrązowy | dunkelbraun | dark brown | tmavě hnědá

09 brązowy | braun | brown | hnědá

Systemy SKP / SAR

BSPW

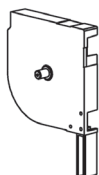
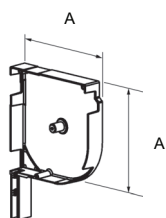

Bok skrzynki wewnętrzny - stopka typ I
Innenblendenkappen - Bolzen Typ I
Internal end cap - pin type I
Bok boxu vnitřní - patka typu I

Pakowanie: para | Packung: Paar | Packing: pair | Balení: pár

	A	
BSPW/137/x	135	1
BSPW/150/x	148	1
BSPW/165/x	163	1
BSPW/180/x	178	1
BSPW/205/x	203	1

x Kolor | Farbe | Colour | Barva

00 nielakierowany | unlackiert | mill finish | nelakovaná

System SKP

BSPWZ

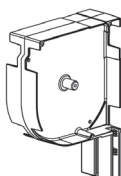
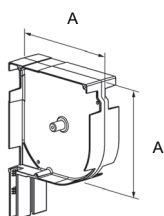

Boki skrzynki wewnętrzne, zespolone - stopka typ I
Zusammengesetzte Innenblendenkappen - Bolzen Typ I
Compound internal end caps - pin type I
Boky boxu vnitřně spojené - patka typu I

Pakowanie: para | Packung: Paar | Packing: pair | Balení: pár

	A	
BSPWZ/137/x	135	1
BSPWZ/150/x	148	1
BSPWZ/165/x	163	1
BSPWZ/180/x	178	1
BSPWZ/205/x	203	1

x Kolor | Farbe | Colour | Barva

00 nielakierowany | unlackiert | mill finish | nelakovaná

Systemy SKP / SAR

BSPWN

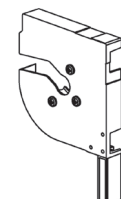

Bok skrzynki wewnętrzny, wspólny napęd - stopka typ I
Innenblendenkappen, gemeinsamer Antrieb - Bolzen Typ I
Internal end cap, common drive - pin type I
Bok boxu vnitřní, společný pohon - patka typu I

Pakowanie: para | Packung: Paar | Packing: pair | Balení: pár

	A	
BSPWN/150/x	148	1
BSPWN/165/x	163	1
BSPWN/180/x	178	1
BSPWN/205/x	203	1

x Kolor | Farbe | Colour | Barva

00 nielakierowany | unlackiert | mill finish | nelakovaná

System SKP

BSO

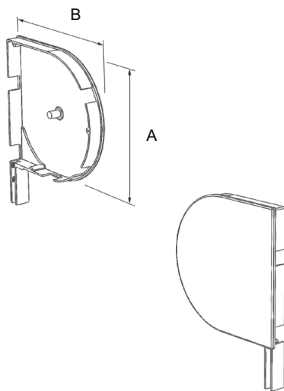

Pokrywa boczna skrzynki owalnej - stopka typ I

Rund-Blendenkappen - Bolzen Typ I

Round end cap 45° - pin type I

Boční kryt oválného boxu - patka typu I

Pakowanie: para | Packung: Paar | Packing: pair | Balení: pár

	A	B	
BSO/137/x	142	147	25
BSO/150/x*	155	160	25
BSO/165/x	170	175	25
BSO/180/x	185	190	25
BSO/205/x	212	217	25

* - wyłącznie w systemie SKO-P | nur im SKO-P system | only in SKO-P system | pouze v systému SKO-P

x Kolor | Farbe | Colour | Barva

00	nielakierowany unlackiert mill finish nelakovaná
01	srebrny silber silver stříbrná
02	biały weiß white bílá
03	szary grau grey šedá
08	ciemnobrązowy dunkelbraun dark brown tmavě hnědá
09	brązowy braun brown hnědá
NEW 22	ultra biały ultraweiß ultra white ultra bílá
23	szary antracyt anthrazitgrau anthracite grey antracitová šedá
40S	biały, perłowy mat weiß, perlmutt matt white, pearl mat bílá, perlový mat
41S	jasny szary, perłowy mat hellgrau, perlmutt matt light grey, pearl mat světle šedá, perlový mat
42S	szary, perłowy mat grau, perlmutt matt grey, pearl mat šedá, perlový mat
43S	szary antracyt, perłowy mat anthrazitgrau, perlmutt matt anthracite grey, pearl mat antracitová šedá, perlový mat
44S	ciemny szary, perłowy mat dunkelgrau, perlmutt matt dark grey, pearl mat tmavě šedá, perlový mat

S - Kolor specjalny na zamówienie | spezielle Farbe – auf Kundenwunsch | Special colour on request | Speciální barva na objednávku

	00	01	02	03	08	09	22	23	40S	41S	42S	43S	44S
BSO/137/x	x	x	x	x	x	x	+	x	x	x	x	x	x
BSO/150/x	x	x	x	x	x	x		x	x	x	x	x	x
BSO/165/x	x	x	x	x	x	x	+	x	x	x	x	x	x
BSO/180/x	x	x	x	x	x	x	+	x	x	x	x	x	x
BSO/205/x	x	x	x	x	x	x	+	x	x	x	x	x	x

Systemy SKO / SKO-P / SAR

BOW

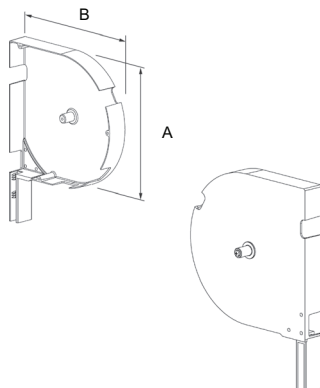

Bok skrzynki owalnej wewnętrzny - stopka typ I

Rund-Innenblendenkappen - Bolzen Typ I

Internal round end cap 45° - pin type I

Bok oválného boxu vnitřní - patka typu I

Pakowanie: para | Packung: Paar | Packing: pair | Balení: pár

	A	B	
BOW/137/x	137	142	1
BOW/150/x*	150	155	1
BOW/165/x	165	170	1
BOW/180/x	180	185	1
BOW/205/x	205	210	1

* - wyłącznie w systemie SKO-P | nur im SKO-P system | only in SKO-P system | pouze v systému SKO-P

x Kolor | Farbe | Colour | Barva

00	nielakierowany unlackiert mill finish nelakovaná
-----------	--

Systemy SKO / SKO-P

BOWZ

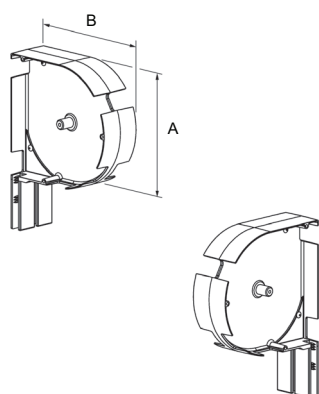

Boki skrzynki owalnej, wewnętrzne zespolone - stopka typ I
Zusammengesetzte-Rund-Innenblendenkappen - Bolzen Typ I
Compound internal round end caps 90° - pin type I
Boky oválného boxu, vnitřně spojené - patka typu I

Pakowanie: para | Packung: Paar | Packing: pair | Balení: pár

	A	B	
BOWZ/137/x	137	142	1
BOWZ/150/x*	150	155	1
BOWZ/165/x	165	170	1
BOWZ/180/x	180	185	1
BOWZ/205/x	205	210	1

* - wyłącznie w systemie SKO-P | nur im SKO-P system | only in SKO-P system | pouze v systému SKO-P

x Kolor | Farbe | Colour | Barva

00 nielakerowany | unlackiert | mill finish | nelakovaná

Systemy SKO / SKO-P / SAR

BOWN

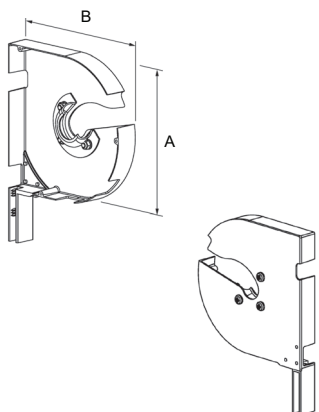

Bok skrzynki owalnej wewnętrzny, wspólny napęd - stopka typ I
Rund-Innenblendenkappen, gemeinsamer Antrieb - Bolzen Typ I
Internal end round cap 45°, common drive - pin type I
Bok oválného boxu vnitřní, společný pohon - patka typu I

Pakowanie: para | Packung: Paar | Packing: pair | Balení: pár

	A	B	
BOWN/150/x*	150	155	1
BOWN/165/x	165	170	1
BOWN/180/x	180	185	1
BOWN/205/x	205	210	1

* - wyłącznie w systemie SKO-P | nur im SKO-P system | only in SKO-P system | pouze v systému SKO-P

x Kolor | Farbe | Colour | Barva

00 nielakerowany | unlackiert | mill finish | nelakovaná

Systemy SKO / SKO-P

BS 90

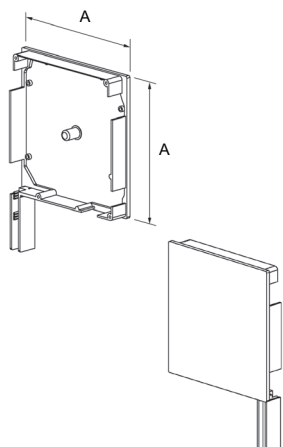

Pokrywa boczna skrzynki 90° - stopka typ I
Blendenkappen 90° - Bolzen Typ I
End cap 90° - pin type I
Boční kryt boxu 90° - patka typu I

Pakowanie: para | Packung: Paar | Packing: pair | Balení: pár

	A	
BS90/137/x	138	25
BS90/150/x	151	25
BS90/165/x	166	25
BS90/180/x	181	25
BS90/205/x	206	25

x Kolor | Farbe | Colour | Barva

00 nielakerowany | unlackiert | mill finish | nelakovaná

Systemy SP-E / SAR

BSW 90

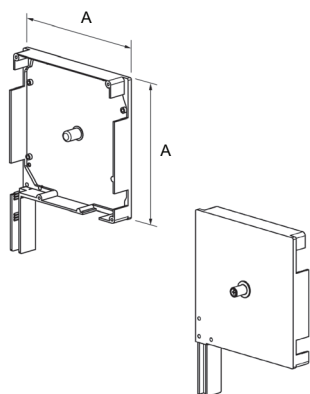

Bok skrzynki 90° wewnętrzny - stopka typ I

Innenblendenkappen 90° - Bolzen Typ I

Internal end cap 90° - pin type I

Bok boxu 90° vnitřní - patka typu I

Pakowanie: para | Packung: Paar | Packing: pair | Balení: pár

	A	
BSW90/137/x	135	1
BSW90/150/x	148	1
BSW90/165/x	162	1
BSW90/180/x	178	1
BSW90/205/x	203	1

x Kolor | Farbe | Colour | Barva

00 nielakierowany | unlackiert | mill finish | nelakovaná

System SP-E

BSWZ 90

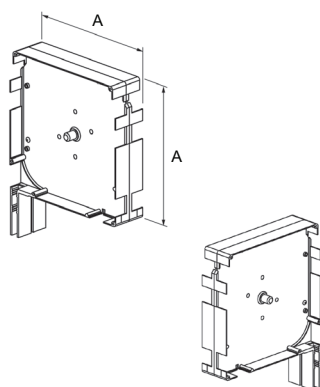

Boki skrzynki 90°, wewnętrzne zespolone - stopka typ I

Zusammengesetzte Innenblendenkappen 90° - Bolzen Typ I

Compound internal end caps 90° - pin type I

Boky boxu 90°, vnitřně spojené - patka typu I

Pakowanie: szt. | Packung: St. | Packing: pcs | Balení: ks

	A	
BSWZ90/137/x	135	1
BSWZ90/150/x	148	1
BSWZ90/165/x	162	1
BSWZ90/180/x	178	1
BSWZ90/205/x	203	1

x Kolor | Farbe | Colour | Barva

00 nielakierowany | unlackiert | mill finish | nelakovaná

Systemy SP-E / SAR

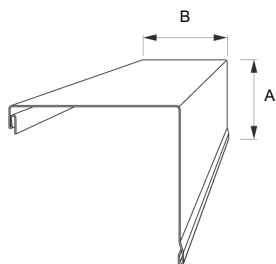
SK / G

Skrzynka bramowa - góra
Garagentorkasten - Oberteil
Shutter box for gates - top
Box vrat - horní strana

Pakowanie: szt. x m | Packung: St. x m | Packing: pcs. x m | Balení: ks x m

	A	B	
SK/G/250/x	255	250	5x4/6
SK/G/300/x	306	300	5x4/6

x Kolor | Farbe | Colour | Barva

01	srebrny silber silver stříbrná
02	biały weiß white bílá
03	szary grau grey šedá
08	ciemnobrązowy dunkelbraun dark brown tmavě hnědá
09	brązowy braun brown hnědá
23	szary antracyt anthrazitgrau anthracite grey antracitová šedá

Systemy BGR / BKR

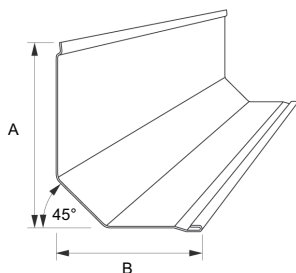
SK 45 / D

Skrzynka bramowa 45° - dół
Garagentorkasten 45° - Unterteil
Shutter box for gates 45° - base
Box vrat 45° - spodní strana

Pakowanie: szt. x m | Packung: St. x m | Packing: pcs. x m | Balení: ks x m

	A	B	
SK45/D/250/x	240	208	5x4/6
SK45/D/300/x	290	250	5x4/6
SK45/D/350/x	350	305	5x4/6

x Kolor | Farbe | Colour | Barva

01	srebrny silber silver stříbrná
02	biały weiß white bílá
03	szary grau grey šedá
08	ciemnobrązowy dunkelbraun dark brown tmavě hnědá
09	brązowy braun brown hnědá
23	szary antracyt anthrazitgrau anthracite grey antracitová šedá

Systemy BGR / BKR

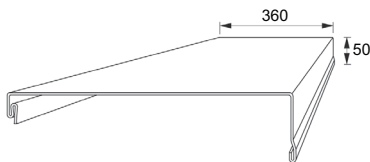
SK / G / 350

Skrzynka bramowa - góra
Garagentorkasten - Oberteil
Shutter box for gates - top
Box vrat - horní strana

Pakowanie: szt. x m | Packung: St. x m | Packing: pcs. x m | Balení: ks x m

- SK/G/350/x**
- stosowana z SK 45/D/350 oraz SK/T/350
 - verwendet mit SK 45/D/350 und SK/T/350
 - used with SK 45/D/350 and SK/T/350
 - používáno s SK 45/D/350 a SK/T/350

x Kolor | Farbe | Colour | Barva

01	srebrny silber silver stříbrná	
02	biały weiß white bílá	5x4/6
03	szary grau grey šedá	5x4/6
08	ciemnobrązowy dunkelbraun dark brown tmavě hnědá	5x4/6
09	brązowy braun brown hnědá	5x4/6
23	szary antracyt anthrazitgrau anthracite grey antracitová šedá	5x4/6

Systemy BGR / BKR

SK / T / 350

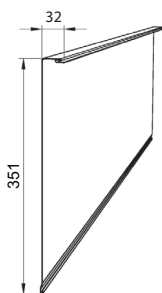

Skrzynka bramowa - tył
Garagentorkasten - Hinterteil
Shutter box for gates - back part
Box vrat - zadní strana

Pakowanie: szt. x m | Packung: St. x m | Packing: pcs. x m | Balení: ks x m

- SK/T/350/x**
- stosowana z SK/G/350 oraz SK 45/D/350
 - verwendet mit SK/G/350 und SK 45/D/350
 - used with SK/G/350 and SK 45/D/350
 - používáno s SK/G/350 a SK 45/D/350

x	Kolor Farbe Colour Barva	
01	srebrny silber silver stříbrná	5x4/6
02	biały weiß white bílá	5x4/6
03	szary grau grey šedá	5x4/6
08	ciemnobrązowy dunkelbraun dark brown tmavě hnědá	5x4/6
09	brązowy braun brown hnědá	5x4/6
23	szary antracyt anthrazitgrau anthracite grey antracitová šedá	5x4/6

Systemy BGR / BKR

SKO-P / G

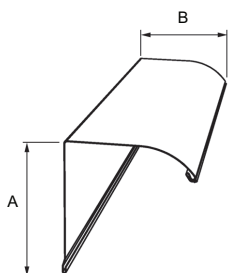

Skrzynka bramowa systemu Owal - góra
Garagentorkasten des OWAL-Systems - Oberteil
Garage shutter box Oval system - top
Box vrat systému OWAL - horní strana

Pakowanie: szt. x m | Packung: St. x m | Packing: pcs. x m | Balení: ks x m

	A	B	
SKO-P/G/230/x	228	216	5x4/6
SKO-P/G/250/x	250	240	5x4/6
SKO-P/G/300/x	300	286	5x4/6

x	Kolor Farbe Colour Barva
02	biały weiß white bílá
99	lakier podkładowy Unterschicht-Lack primer podkladový lak

Systemy BGR / BKR

SKO-P / D

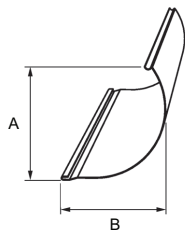

Skrzynka bramowa systemu Owal - dół
Garagentorkasten des OWAL-Systems - Unterteil
Garage shutter box Oval system - base
Box vrat systému OWAL - spodní strana

Pakowanie: szt. x m | Packung: St. x m | Packing: pcs. x m | Balení: ks x m

	A	B	
SKO-P/D/230/x	185	199	5x4/6
SKO-P/D/250/x	197	217	5x4/6
SKO-P/D/300/x	235	261	5x4/6

x	Kolor Farbe Colour Barva
02	biały weiß white bílá
99	lakier podkładowy Unterschicht-Lack primer podkladový lak

Systemy BGR / BKR

BS 45

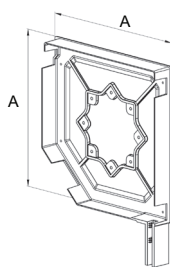

Pokrywa boczna skrzynki 45° - stopka typ II

Blendenkappen 45° - Bolzen Typ II

End cap 45° - pin type II

Boční kryt boxu 45° - patka typu II

Pakowanie: para | Packung: Paar | Packing: pair | Balení: pár

	A	
BS45/250/x	252	6
BS45/300/x	302	6

x	Kolor Farbe Colour Barva
00	nielakierowany unlackiert mill finish nelakovaná
01	srebrny silber silver stříbrná
02	biały weiß white bílá
03	szary grau grey šedá
08	ciemnobrązowy dunkelbraun dark brown tmavě hnědá
09	brązowy braun brown hnědá
23	szary antracyt anthrazitgrau anthracite grey antracitová šedá

Systemy BGR / BKR

BS 45 / K / 350

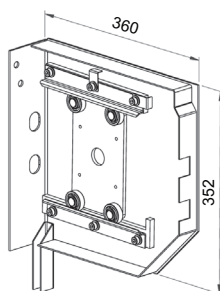

Pokrywa boczna skrzynki 45° z konsolą - stopka typ II

Blendenkappen 45° mit Konsole - Bolzen Typ II

End cap 45° with console - pin type II

Boční kryt boxu 45° s konzolou - patka typu II

Pakowanie: para | Packung: Paar | Packing: pair | Balení: pár

- BS45/K/350/x**
- do kraty oraz bramy garażowej
 - für Gitter und Garagentore
 - for grills and garage door
 - k mřížů a garážovým vratům

x	Kolor Farbe Colour Barva	
00	nielakierowany unlackiert mill finish nelakovaná	1
01	srebrny silber silver stříbrná	1
02	biały weiß white bílá	1
03	szary grau grey šedá	1
08	ciemnobrązowy dunkelbraun dark brown tmavě hnědá	1
09	brązowy braun brown hnědá	1
23	szary antracyt anthrazitgrau anthracite grey antracitová šedá	1

Systemy BGR / BKR

BSO

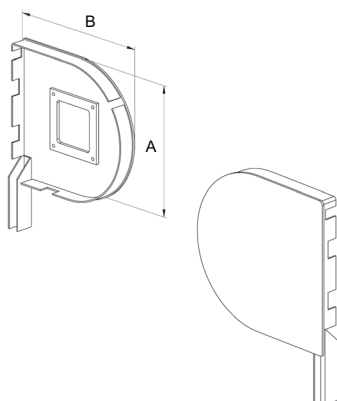

Pokrywa boczna skrzynki owalnej - stopka typ II

Rund-Blendenkappen - Bolzen Typ II

Round end cap 45° - pin type II

Boční kryt oválného boxu - patka typu II

Pakowanie: para | Packung: Paar | Packing: pair | Balení: pár

	A	B	
BSO/230/x	230	240	6
BSO/250/x	252	262	6
BSO/300/x	302	312	6

x	Kolor Farbe Colour Barva
00	nielakierowany unlackiert mill finish nelakovaná
02	biały weiß white bílá

Systemy BGR / BKR

KBS 45

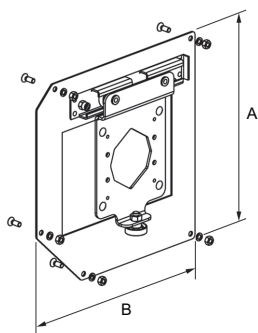

Konsola do pokryw bocznych Konsole für Blendenkappen Consoles for end caps Konzola k bočním krytům

Pakowanie: para | Packung: Paar | Packing: pair | Balení: pár

KBS45

- ocynkowana, stosowana z pokrywami bocznymi BS 45/250 i BS 45/300
- verzinkt, verwendet mit den Blendenkappen BS 45/205 und BS45/300
- galvanized, used with end caps BS 45/250 and BS 45/300
- pozinkováno, používáno s bočními kryty BS 45/250 a BS 45/300

	A	B	
KBS45/250	237	238	1
KBS45/300	287	288	1

Systemy BGR / BKR

KNB

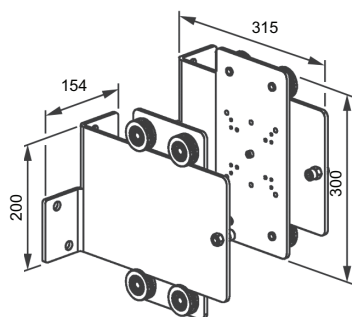

Konsola Konsole Console Konzola

Pakowanie: 1 para | Packung: 1 Paar | Packing: 1 pair | Balení: 1 pár

KNB

- ocynkowana, do kraty oraz bramy garażowej.
Max obciążenie konsoli 250 kg.
- verzinkt, für Rollgitter und Garagenrolltore.
Die Maximale Belastung für die Konsole ist 250 kg.
- galvanized, for grille and garage door.
The maximumload of the konsole is 250 kg.
- pozinkováno, k mříži a garážovým vratům.
Maximální zatížení konzolí - 250 kg

Systemy BGR / BKR

LS

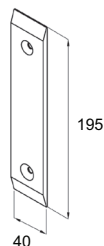

Listwa ślizgowa Gleitplatte Slide slat Kluzná lišta

Pakowanie: 1 szt. | Packung: 1 St. | Packing: 1 pcs | Balení: 1 ks

LS

- stosowana z KNB, KBS 45, BS 45/K/350, KNJ
- verwendet mit KNB, KBS 45, BS 45/K/350, KNJ
- used with KNB, KBS 45, BS 45 /K/350, KNJ
- používáno s KNB, KBS 45, BS 45 /K/350, KNJ

Systemy BGR / BKR / BPR

WPB

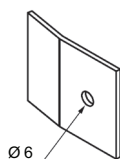

Wspornik do montażu pokryw bocznych Montageplatte für Blendenkappen Plate for end caps Podpěra pro montáž bočních krytů

Pakowanie: 1 szt. | Packung: 1 St. | Packing: 1 pcs | Balení: 1 ks

WPB

- do montażu pokryw bocznych: BS_45, BS 45, BSP, BSO, BS 90
- für die Montage der Blendenkappen: BS_45, BS 45, BSP, BSO, BS 90
- for end caps installation: BS_45, BS 45, BSP, BSO, BS 90
- k montáži bočních krytů: BS_45, BS 45, BSP, BSO, BS 90

Systemy BGR / BKR